





FINITURE LAVABO / WASHBASIN FINISHES







Essential colors

-  Bianco / white glossy
-  Nero / black glossy
-  Fumo - glossy
-  Talpa - glossy
-  Cioccolato - glossy

Le Terre di Cielo

-  Talco
-  Lavagna
-  Arenaria
-  Muschio
-  Pomice
-  Cemento
-  Avena
-  Polvere
-  Brina
-  Fango
-  Lino
-  Cipria
-  Basalto
-  Cacao
-  Agave
-  Canapa

Le Acque di Cielo

-  Oltremare
-  Corallo
-  Smeraldo
-  Ninfea
-  Alga
-  Anemone

MOBILE VERSIONE LISCIA / CABINET SMOOTH VERSION







Essential colors

-  Fumo - glossy
-  Talpa - glossy





Le Terre di Cielo

-  Talco
-  Arenaria
-  Pomice
-  Avena
-  Brina
-  Muschio
-  Basalto
-  Agave
-  Cemento

Le Acque di Cielo

-  Oltremare
-  Corallo
-  Smeraldo
-  Ninfea
-  Alga
-  Anemone

Essenze / wood essences

-  Rovere Sbiancato
-  Rovere Naturale
-  Rovere Nero
-  Rovere Tinto Noce
-  Eucalipto

ATTENZIONE:

Superfici, pesi e misure riportate possono presentare leggere differenze rispetto ai pezzi reali, in considerazione e accordo delle caratteristiche di tolleranza intrinseche del materiale ceramico e del suo processo produttivo. L'azienda si riserva di cambiare schede tecniche e caratteristiche di funzionamento degli articoli in ogni momento e senza necessità di preavviso.

ATTENTION:

Surfaces, weights and dimensions can show some little differences compared to the real item, following typical intrinsic characteristics of ceramics material and production. The company reserves the right to change any technical specifications/dimension and/or operating characteristics of the products at any time and without giving notice.

ACCESSORI / ACCESSORIES

Pilette / click-clack drains:

ITPILFREEGNM - Piletta click-clack NERO MATT con coperchio in ceramica
Click-clack drain in MATT BLACK with ceramic lid

Sifoni / siphons:

SISP - Sifone CROMO
CHROME siphon

SIFN - Sifone NERO MATT
MATT BLACK siphon

SIFBR - Sifone BRONZO
BRONZE siphon

SIFCM - Sifone CEMENTO
CEMENTO siphon

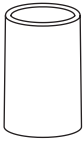

lavabo freestanding / freestanding washbasin
art. ITFREEC / ITFREEP
peso netto / net weight: 61,00 / 60,00 Kg

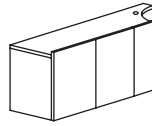

mobile / cabinet
art. ITMS128SXL / ITMS128SXE / ITMS128SXL SF / ITMS128SXESF
peso netto / net weight: 38,00 / 35,00 Kg

Aprile 2026

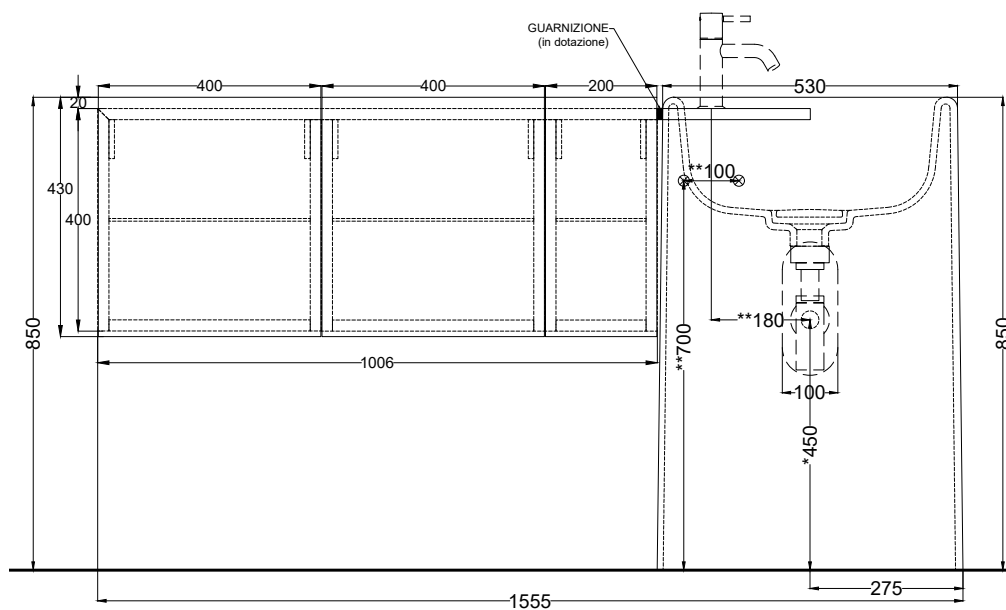

NOTE:
 * = water outlet (with standard siphon)
 ** = water inlet (hot/cold)

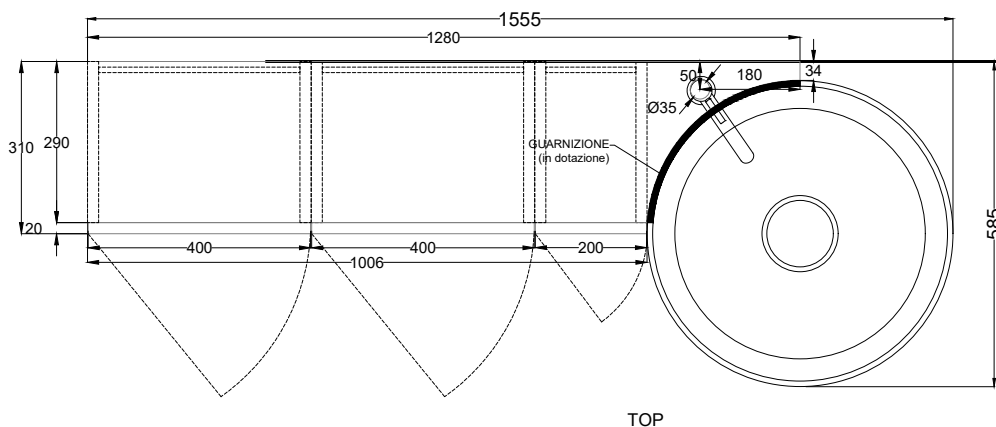

TOP

ATTENZIONE:
 Superfici, pesi e misure riportate possono presentare leggere differenze rispetto ai pezzi reali, in considerazione e accordo delle caratteristiche di tolleranza intrinseche del materiale ceramico e del suo processo produttivo. L'azienda si riserva di cambiare schede tecniche e caratteristiche di funzionamento degli articoli in ogni momento e senza necessità di preavviso.

ATTENTION:
 Surfaces, weights and dimensions can show some little differences compared to the real item, following typical intrinsic characteristics of ceramics material and production. The company reserves the right to change any technical specifications/ dimension and/or operating characteristics of the products at any time and without giving notice.

lavabo freestanding tondo con mobile sospeso 128 destro
freestanding washbasin with wall-hung cabinet 128 on the right

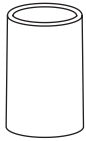

lavabo freestanding / freestanding washbasin
art. ITFREEC / ITFREEP
peso netto / net weight: 61,00 / 60,00 Kg

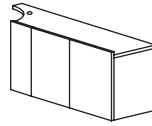

mobile / cabinet
art. ITMS128DXL / ITMS128DXE / ITMS128DXLSF / ITMS128DXE
peso netto / net weight: 38,00 / 35,00 Kg

Aprile 2026

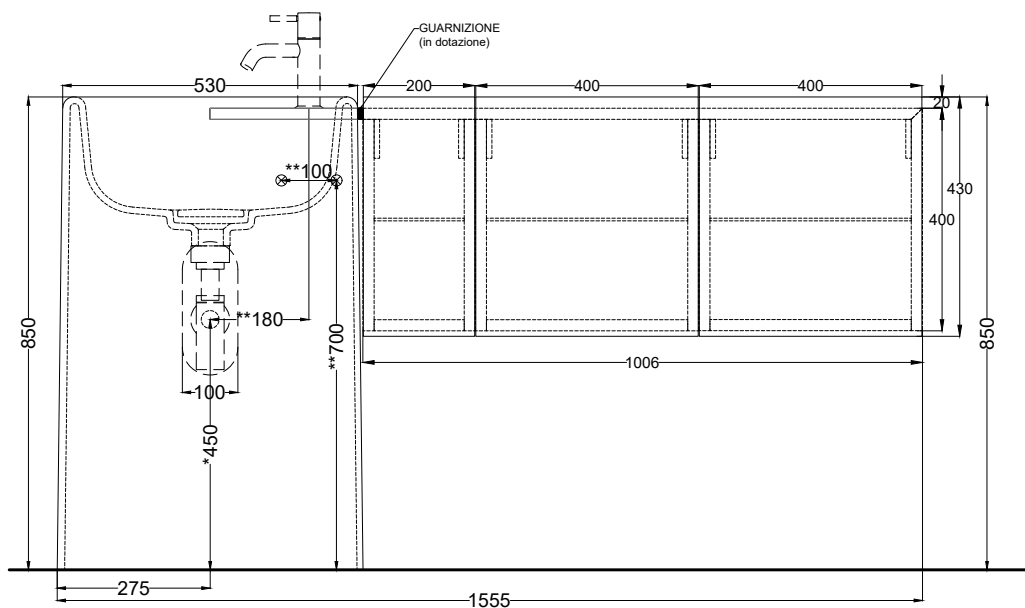

NOTE:

- * = water outlet (with standard siphon)
- ** = water inlet (hot/cold)

FRONT

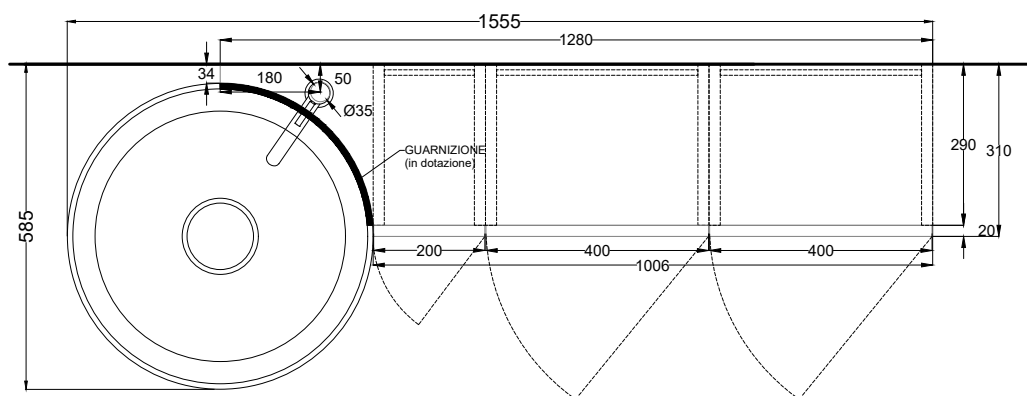

TOP

ATTENZIONE:
 Superfici, pesi e misure riportate possono presentare leggere differenze rispetto ai pezzi reali, in considerazione e accordo delle caratteristiche di tolleranza intrinseche del materiale ceramico e del suo processo produttivo. L'azienda si riserva di cambiare schede tecniche e caratteristiche di funzionamento degli articoli in ogni momento e senza necessità di preavviso.

ATTENTION:
 Surfaces, weights and dimensions can show some little differences compared to the real item, following typical intrinsic characteristics of ceramics material and production. The company reserves the right to change any technical specifications/ dimension and/or operating characteristics of the products at any time and without giving notice.