



PESO NETTO/NET WEIGHT: 8,50 Kg

PCS PALLET: 24
PCS PALLET CONTAINER: 48

ACCESSORI/ACCESSORIES:

PIL01 - Piletta universale click-clack CROMO con coperchio in ceramica / *Universal click-clak drain in CHROME with ceramic lid*
PIL01NM - Piletta universale click-clack NERO MATT con coperchio in ceramica / *Universal click-clak drain in MATT BLACK with ceramic lid*
PIL01BR - Piletta universale click-clack BRONZO con coperchio in ceramica / *Universal click-clak drain in BRONZE with ceramic lid*
PIL01CM - Piletta universale click-clack CEMENTO con coperchio in ceramica / *Universal click-clak drain in CEMENTO with ceramic lid*

SISP - Sifone CROMO / *CHROME siphon*

SIFN - Sifone NERO MATT / *MATT BLACK siphon*

SIFBR - Sifone BRONZO / *BRONZE siphon*

SIFCM - Sifone CEMENTO / *CEMENTO siphon*

FINITURE

FINISHES

- Bianco/white - glossy
- Nero/black - glossy
- Fumo - glossy
- Talpa - glossy

Le Terre di Cielo

- Talco
- Pomice
- Brina
- Basalto
- Lavagna
- Cemento
- Fango
- Cacao
- Arenaria
- Avena
- Lino
- Agave
- Muschio
- Polvere
- Cipria
- Canapa

Le Acque di Cielo

- Oltremare
- Smeraldo
- Alga
- Corallo
- Ninfea
- Anemone



DoP No. 14688.01

Febbraio 2026

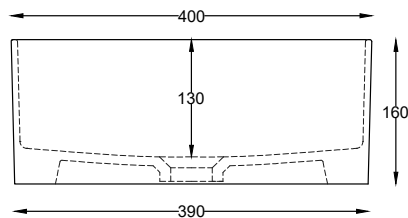
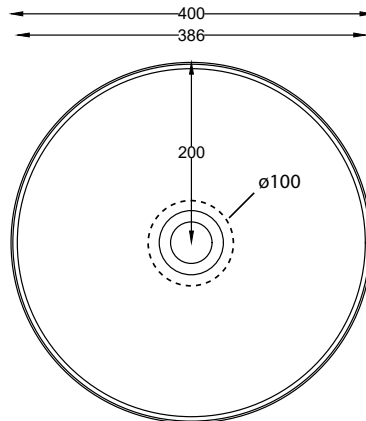

ATTENZIONE:
Superfici, pesi e misure riportate possono presentare leggere differenze rispetto ai pezzi reali, in considerazione e accordo delle caratteristiche di tolleranza intrinseche del materiale ceramico e del suo processo produttivo. L'azienda si riserva di cambiare schede tecniche e caratteristiche di funzionamento degli articoli in ogni momento e senza necessità di preavviso.

ATTENTION:
Surfaces, weights and dimensions can show some little differences compared to the real item, following typical intrinsic characteristics of ceramics material and production. The company reserves the right to change any technical specifications/dimension and/or operating characteristics of the products at any time and without giving notice.